

swissvoice

Xtra 3355 Combo



USER'S GUIDE

QUICK SETUP

Set Language

After first time power up (base station is also connected to main power, for details, refer to Section 5.1.2.). LANGUAGE? will appear on the screen.

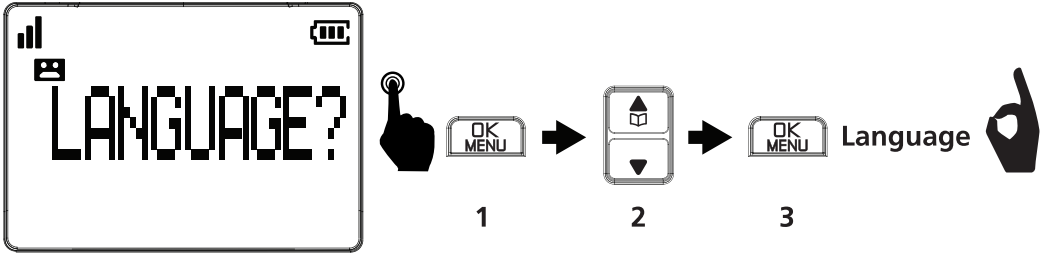

1. Press **Ok** on the handset.
2. Press **▲** or **▼** to select the desired language.
3. Press **Ok**. You hear confirmation tones and OK will appear on the screen. (For Duo or Trio version, you just set 1 of handsets, the other handset(s) will be changed accordingly)

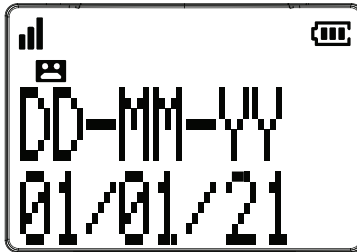

OR

1. Press **Ok** on the handset in idle mode.
2. Press **▲** or **▼** to select **HS Setting**, then press **Ok**.
3. Press **▲** or **▼** to select **Date / Time**, then press **Ok**.
4. Press **▲** or **▼** to select **Set Date**, then press **Ok**, Input the day, month, year, then press **Ok**, input hour (24HR format), and minutes, then press **Ok**, You hear confirmation tones.

Note: if digit is input wrong during input Date or Time, you can press **▲** or **▼** to select the right position and input correct digit.

Package Contents

This package contains the following items:

1. Cordless handset
2. Cordless handset charger
3. Combo base unit
4. Combo Handset unit
5. Coiled Cord
6. AC power adaptors (1 for combo base unit and 1 for cordless handset charger)
7. Telephone line cord
8. Telephone plug convertor (optional)
9. 3pcs of AAA 500mAh NiMH rechargeable batteries
10. User Guides
11. 4 pcs of spare transparent photo covers

The duo or trio package contains the repeating items:

- Cordless Handset(s)
- Cordless handset charger(s)
- Mains power adapter(s)
- AAA 500mAh NiMH rechargeable batteries

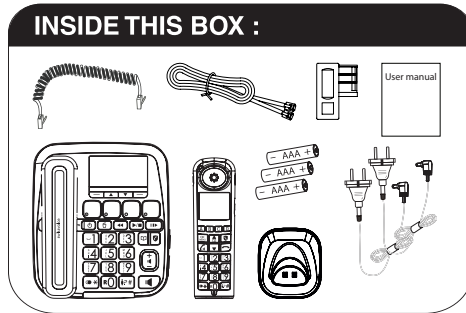

TABLE OF CONTENT

1.	IMPORTANT SAFETY INSTRUCTIONS.....	6
2.	LOCATION.....	6
3.	INSTALLING YOUR PHONE.....	7
3.1.	Connecting the Base Station.....	7
3.2.	Connecting the Charger.....	8
3.3.	Installing and charging the batteries.....	8
4.	GETTING TO KNOW YOUR PHONE.....	9
4.1.	Base Station Overview.....	9
4.2.	Display Icons and Symbols of Combo Base.....	11
4.3.	Menu tree of base.....	12
4.4.	Handset Overview.....	14
4.5.	Menu tree of handset.....	16
5.	USING YOUR PHONE.....	18
5.1.	Set Date & Time and Language.....	18
5.1.1.	Set Date & Time.....	18
5.1.2.	Change language.....	18
5.2.	Make a Call.....	18
5.2.1.	Preparatory Dialing.....	18
5.2.2.	Direct Dialing.....	19
5.2.3.	Call from the phonebook.....	19
5.2.4.	Call from the Call List.....	19
5.2.5.	Call from the redial list.....	19
5.2.6.	Call direct memories (A, B, C , D) on base or on handset.....	19
5.2.7.	Call the indirect memories (Key 1 to Key 9).....	19
5.3.	Answer a Call.....	19
5.4.	End a Call.....	19
5.5.	Set Photo A, B, C, D key memories.....	20
5.5.1.	Input number and name.....	20
5.5.2.	Record your own voice tag.....	20
5.5.3.	Play Voice tag.....	20
5.5.4.	Delete Voice tag.....	21
5.5.5.	View record of Photo memory.....	21
5.5.6.	Edit record of Photo memory.....	21
5.5.7.	Adjust Earpiece and Handsfree Volume.....	22
5.6.	Audio Boost.....	22
5.7.	Equalizer.....	22
5.8.	Redial.....	22
6.	PHONEBOOK.....	22
6.1.	Add a new phonebook entry.....	22
6.2.	View a phonebook entry.....	23
6.3.	Search a phonebook entry.....	23
6.4.	Edit a phonebook entry.....	23
6.5.	Store phonebook in speed dial.....	23
6.6.	Delete a phonebook entry.....	23
6.7.	Add to speed dial key.....	23
6.8.	Status of phonebook.....	24
7.	PHONE SETTINGS.....	24
7.1.	Set Ringer Melody and Volume.....	24
7.2.	Set Alert Tone.....	24
7.3.	Set the Date and Time.....	24
7.4.	Talking Digit.....	24
7.5.	Change the Flash Time.....	25
7.6.	Reset Your Phone.....	25
8.	Registration Cordless Handset to Telephone Base.....	25
8.1.	Registration.....	25
8.2.	Locate the Cordless Handset.....	25
8.3.	Conference call.....	25
8.4.	Transfer a call.....	26
8.5.	Intercom.....	26
8.6.	Answer a call / Auto answer (Cordless handset only).....	26
8.7.	Enriched ringer.....	27
9.	REMINDER.....	27
9.1.	Turn on alarm reminder, set time and frequency.....	27
9.2.	Select melody of the alarm reminder.....	27
9.3.	Rename the alarm reminder.....	27

9.4.	Record Voice memo of the alarm reminder.....	27
10.	SPEED DIAL KEYS (KEY 1 TO KEY 9).....	28
10.1.	Store a speed dial entry.....	28
10.2.	View a speed dial entry.....	28
10.3.	Edit a speed dial entry.....	28
10.4.	Delete a speed dial entry.....	28
11.	CALLER DISPLAY (network dependent).....	29
11.1.	View the call list.....	29
11.2.	Store a call list number into the phonebook.....	29
11.3.	Store a call list number into the black list.....	29
11.4.	Delete an entry in the call list.....	30
11.5.	Delete the entire list of the call list.....	30
11.6.	Call waiting.....	30
12.	CALL BLOCK.....	30
12.1.	Manual call block mode.....	31
12.1.1.	Enable MANUAL mode.....	31
12.2.	Add numbers to Blocklist.....	31
12.3.	Edit numbers in Blocklist.....	31
12.4.	Delete a number in Blocklist.....	31
12.5.	Delete all numbers from Blocklist.....	31
12.6.	Automatic call block mode.....	32
12.6.1.	VIPS only.....	32
12.6.2.	Contacts only.....	32
12.7.	Anonymous call block mode.....	32
12.7.1.	Block Private Calls.....	32
12.7.2.	Block All Anonymous Calls.....	32
12.8.	Set Block Anonymous Calls OFF.....	33
13.	VOICE MAIL (Network Dependent).....	33
14.	ANSWERING MACHINE.....	33
14.1.	Turn On/Off the answering machine.....	33
14.2.	Message playback.....	33
14.3.	Options during playback.....	33
14.4.	Listen new messages through the base.....	34
14.5.	Delete old messages in the answering machine.....	34
14.5.1.	Delete all old messages through the handset.....	34
14.5.2.	Delete a message through the base.....	34
14.5.3.	Delete all old messages through the base.....	34
14.5.4.	Record a memo.....	34
14.6.	Outgoing message (OGM).....	34
14.6.1.	Play your outgoing message (OGM).....	35
14.6.2.	Record your own outgoing message (OGM).....	35
14.7.	Delete your outgoing message.....	35
14.8.	Answering machine settings.....	35
14.8.1.	Set the answer mode.....	35
14.8.2.	Set the answer delay.....	36
14.8.3.	Recording time.....	36
14.8.4.	Answering machine remote access.....	36
14.8.5.	Activate remote access.....	36
14.8.6.	Change the remote code.....	37
14.9.	How to access remotely to your answering machine?.....	37
14.10.	Call screening.....	37
14.11.	Message alert tone.....	38
15.	TECHNICAL SPECIFICATIONS.....	38
16.	TROUBLESHOOTING.....	38
17.	GUARANTEE.....	40
18.	SAFETY.....	41
19.	ENVIRONMENT.....	41

1. IMPORTANT SAFETY INSTRUCTIONS

When using your telephone equipment, basic safety precautions should always be stuck to reduce the risk of fire, electric shock and injury, including the followings:

1. Read and understand all the instructions.
2. Follow all warnings and instructions marked on the product.
3. Unplug this product from the wall outlet before cleaning. Do not use liquid cleaners or aerosol cleaners. Use a damp cloth for cleaning.
4. To avoid hearing damage, please make sure anyone who uses this product is aware that the product can produce loud sound when Audio boost function is on.
5. Do not use this product near water (for example, near a bath tub, kitchen sink, swimming pool).
6. Do not expose the telephone to direct sunlight or extreme cold environment. Do not put the telephone close to a heating source such as radiators, cookers, etc.
7. Do not overload wall outlets and extension cords as this can result in the risk of fire or electric shock.
8. NEVER use your phone outdoors during a thunderstorm-unplug the base from the telephone line and the mains socket when there are storms in your area.
9. Do not use the telephone to report a gas leak in the vicinity of the leak.
10. Use only the supplied NiMH (Nickel Metal Hydride) batteries! The operation periods for the handsets are only applicable with the default battery capacities.
11. The use of other battery types or non-rechargeable batteries/primary cells can be dangerous. These may cause interference and/or unit damages. The manufacturer will not be held liable for damage arising from such noncompliance.
12. Do not use third party chargers. The batteries may be damaged.
13. Dispose of batteries safely. Do not immerse them in water, burn them, or put them where they could get punctured.

2. LOCATION

For maximum coverage and reduce the interference, here are some guidelines you should consider when you place the base unit,

- place it at a convenient, high, and central location with no obstructions between the handset and base unit in an indoor environment.
- place it away from electronic appliances such as televisions, microwave ovens, radios, personal computers, wireless devices or other cordless phones.
- avoid facing radio frequency transmitters, such as external antennas of mobile phone cell stations.
- avoid plugging it into the same circuit as other major household electrical appliances because of the potential for interference.

Try moving the appliance or the base unit to another power outlet.

If the reception for a base unit location is not satisfactory, move it to another location for better reception.

Depending on the surrounding conditions as well as spatial and structural factors, the range may be reduced. The range indoors is normally less than outdoors.

3. INSTALLING YOUR PHONE

3.1. Connecting the Base Station

1. Plug one end of the telephone line cord into the telephone jack on base bottom.
2. Plug the small end of power adapter into a power jack on base bottom.
3. Plug the large end of power adapter into a wall power outlet.
4. Plug the other end of the telephone line cord in to the telephone jack or micro-filter.
5. Always use the cables provided in the box.

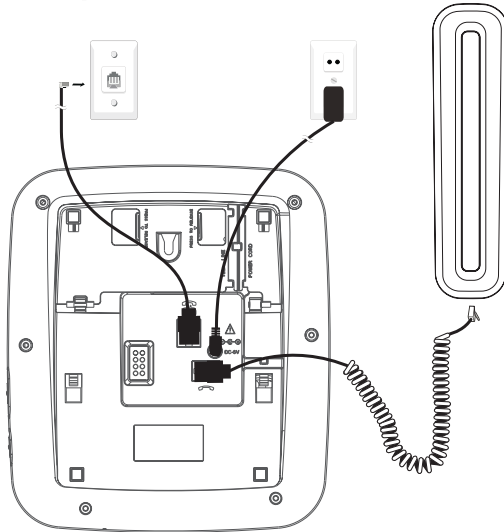
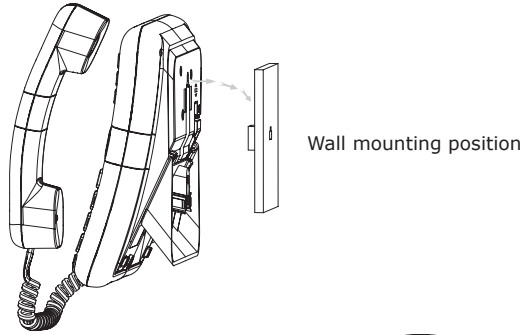

3.2. Connecting the Charger

Plug the power adapter into a mains socket.

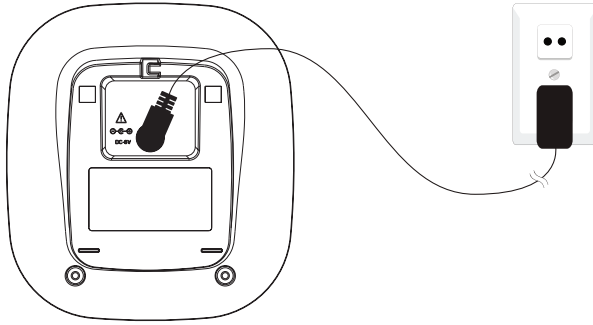

If you have a Broadband line.

If you connect your telephone to a line with a broadband connection, you will need to insert a micro-filter between the telephone and the telephone line, otherwise you may get interference between the telephone and the broadband, which could cause problems.

In a fixed line with broadband, every telephone must have a micro-filter connected, not just the one at the telephone point that your modem is connected to. If you need more broadband micro-filters, contact your broadband supplier

3.3. Installing and charging the batteries

1. Slide down to open the battery compartment cover.
2. Place the 3 supplied AAA-size NiMH rechargeable batteries as indicated. Pay extra attention to direction of polarity.

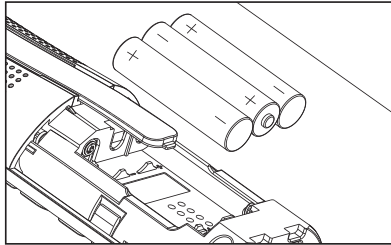

3. Slide the battery compartment cover back.
4. Put the handset on the base and charge for **15 hours** before using the handset for the first time.

Notes:

1. Use only the supplied NiMH rechargeable battery cells.
2. If the handset will not be used for a long time, disconnect and remove the batteries to prevent possible leakage.

4.
4.1.

GETTING TO KNOW YOUR PHONE
Base Station Overview

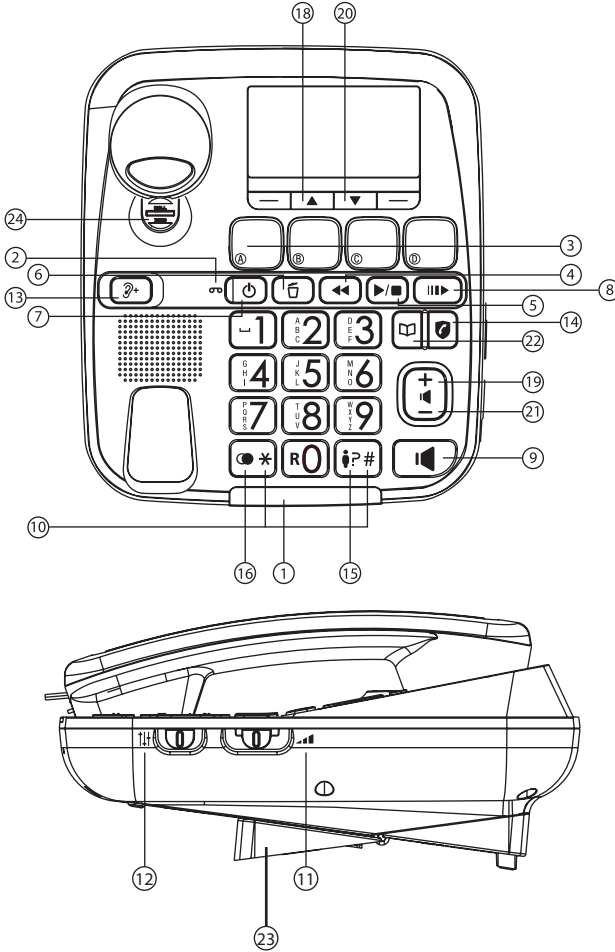

1. INCOMING CALL LED

- Flashes when there is an incoming call.
- On when the phone is in use.
- On when a device is being registered.
- On when another telephone is in line on the same.

2. MESSAGE LED

- On when the answering system is on.
- Flashes when there are new messages/memos in the answering system.
- Flashes slowly when pressing **III▶** for slow play.

3. DIRECT MEMORY KEYS (A, B, C, D)

- Press to dial out phone number stored.

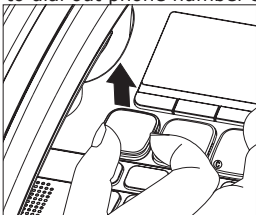



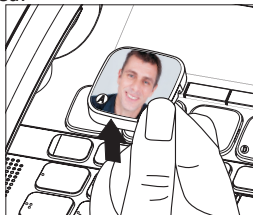

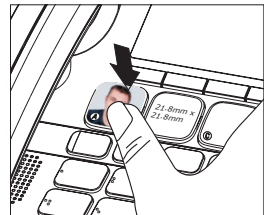

1





2



3

4. 
 - Press to repeat playing the current message from the beginning.
 - Press twice to skip backward to the previous message.
5. 
 - Press to play the message.
 - Press again to stop the message playback.
6. 
 - Press to delete the message currently playing.
 - In idle mode, long press to delete all old messages.
7. 
 - Press to turn on the answering machine.
 - Press again to turn off the answering machine.
8. 
 - Press to slow down the message playback.
9. 
 - Press to make, answer or end a call through base speaker.
 - Press to switch between the combo handset and the base speakerphone during a call.
 - Orange LED is on during speaker mode.
10. **ALPHANUMERIC KEYPAD / * / #**
 - In idle / pre-dial / editing mode / during a call: Press to enter numbers.
 - Press any key to answer an incoming call.
 - During a call: Press and hold **RO** to answer an incoming call when you receive a call waiting alert*.

*Subject to subscription and availability of the service from the fixed line operator.

11. 
 - During a call: Slide up and down to increase the volume /decrease the volume.
 - During message playback: Press to adjust the volume.
12. 
 - Sound experience: select "NATURAL", "BASS" or "TREBLE" during a call BASS (lowest position) NATURAL (mid position) TREBLE (highest position)



BASS (lowest position)

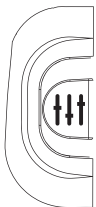



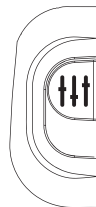



NATURAL
(mid position)



TREBLE (highest position)

 Warning: The product may emit high volume of sound. Take Extra Care when you use audio boost key, recommend you to adjust suitable volume by setting minimum, and then turn on audio boost key.

13. 
 - Press to enhance the clarity and loudness through earpiece of the base during a call.
14. **CALL BLOCK** 
 - In Idle mode: Press to go to **Call Block** menu.
 - In ringing call number: Press to block incoming call number if **Block Set** is set to ON.
15. **CALL LIST** 
 - In idle mode: Press to access the Call List.
16. **REDIAL LIST** 
 - Press these keys to confirm the options on the screen above the keys.
17. **SOFT KEYS**
 - Press these keys to confirm the options on the screen above the keys.
18. **UP KEY** 
 - In menu mode: Press to scroll up the menu items.
 - In Phonebook list / Redial list / Call List: Press to scroll up the list.
 - While entering names or numbers: Press to move the cursor to the left.
19. **VOLUME INCREASE KEY** 
 - During a call and message playback: Press to increase the volume.

20. DOWN KEY ▼

- In menu mode: Press to scroll down the menu items.
- In Phonebook list / Redial list / Call List: Press to scroll down the list.
- While entering names or numbers: Press to move the cursor to the right.



















21. VOLUME DECREASE KEY —

- During a call and message playback: Press to decrease the volume.

22. PHONEBOOK 

- In idle mode: Press to access the phonebook.

23. BASE STAND IN WALL MOUNTING POSITION**24. KNOB FOR WALL MOUNTING POSITION****4.2. Display Icons and Symbols of LCD**

Display icons	Description
	Soft key icon for confirm selection and save input data. - For Base only
	Full battery power level. - For Handset only
	2/3 battery power level. - For Handset only
	1/3 battery power level. - For Handset only
	Flashes when the battery is low and needs charging. - For Handset only
	The speakerphone is in use.
	On: if the handset ringer is turned off.
	On: when there are received new Voice Message Waiting (VMWI) not yet read*. Disappear: when all the voice messages have been read. (Network service dependent)*
	 displays when there the signal strength is strong. - For Handset only  displays when there the signal strength is moderate.  displays when there the signal strength is weak. Off when handset is out of range from the base.
	On: New call list- Missed and new calls.
	On: The answering system (TAM) is turned on. Flashes: when new TAM message is received. Off: The answering system (TAM) is turned off.
	On: when an alarm is set. Off: when an alarm is off.
	On: when audio booster is activated (in earpiece mode). Off: when audio booster is deactivated.
	On: when the telephone line is in use. Flashes: when there is an incoming call.
	On: when the entry in call list is a contact saved in black list.

4.3. Menu tree of base

MAIN MENU	Level 1	Level 2	Level 3	Level 4	Level 5	
Call List	FIRST ENTRY	View				
	Add To PB	VIP X			
			VIP OK			
	LAST ENTRY	Add To Block				
		Delete	Confirm?			
		DeleteAll	Confirm?			
Phonebook	All	FIRST ENTRY	Add new	Number	Name	
		Status			
		LAST ENTRY	View			
			Edit	Name	Number	
			Delete	Confirm?		
			DeleteAll	Confirm?		
			Add to SD	KEY 1		
				KEY 2		
					
				KEY 9		
		Speed Dial	Key 1	Add new	Number	Name
			Key 2	View		
		Edit			
		KEY 9	Delete	Confirm?		
Call Block	Block Set	Off *	Saved			
		On	Saved			
		VIP OK	Saved			
			Contacts OK	Saved		
	Blocklist	FIRST ENTRY	Add new	Number	Name	
		View			
		LAST ENTRY	Edit			
			Delete	Confirm?	Deleted	
			Delete All	Confirm?	Deleted	
			Status	Used		
	Block Anonym	Off *	Saved			
		Private	Saved			
All		Saved				
Direct Mem.	A	Add new	Number	Name		
	..B...C...D	Voice Tag	Playback	Playing		
			Delete	Deleted		
			Record	Recording		
		View				
		Edit	Number	Name		
		Delete	Confirm?			
Ans.Machine	Delete All	Confirm?				
		No Msg.				
	Memo	Recording				
		Playing				
	OGM	Ans & Rec *	Play OGM	Playing		
			Rec. OGM	Recording		
			Delete	Deleted		
		Answer Only	Play OGM			
			Rec. OGM	Recording		
			Delete	Deleted		
	Answer Mode	Ans & Rec *				
		Answer Only	Play OGM			
	Tam Settings	BS Screening	Off *			
			On			
			Answer Delay	Rings 2		
				Rings 4		
				Rings 6 *		
				Rings 8		
			Rings 10			
		Record Time	60 s *			
			120 s			
			180 s			
		Remote Acc.	Off *			
			On			
	Change Pin	PIN?				
	Msg Alert	Off *				
		On				
	Language	English *				
		Francais				
		Deutsch				
		Italiano				
		Nederlands				
		Espanol				
		Portugues				
		Dansk				
		Svenska				

BS Setting	BS Ringer	Melody 1			
		Melody 2			
		Melody 3*			
				
		Melody 12			
	Ring Vol	Volume 1			
		Volume 2*			
				
		Volume 5			
		Off			
	Key Tone	On *			
		Off			
	Enrich Ring	On			
		Off*			
	Flash Time	Short *			
		Medium			
		Long			
	Dial Mode	Tone *			
		Pulse			
	Language	English *			
		Francais			
		Deutsch			
		Italiano			
		Nederlands			
		Espanol			
		Portugues			
		Dansk			
		Svenska			
	Date / Time	Date Format	DD-MM-YY *		
			MM-DD-YY		
		Time Format	24 HR *		
			12 HR		
		Set Time	Set Date		
	Delete Hs	1234			
	Default	Confirm?			
Talk Digit	On/Off	On *			
		Off			
Reminder	ALARM 1	On/Off	ON	Frequency	Once
	...ALARM 10		Off	Saved	Daily
					Mon-Fri
					Sat- Sun
		Melody	Melody 1		
				
			Melody 12		
		Rename	ALARM 1		
		Voice Tag	Playback	Playing	
			Record	Recording	
			Delete	Deleted	
Intercom	Handset x				

Hearing Aid Compatibility:

Special feature which helps to eliminate background noise and interference when you use this telephone with a hearing aid.

4.4. Handset Overview

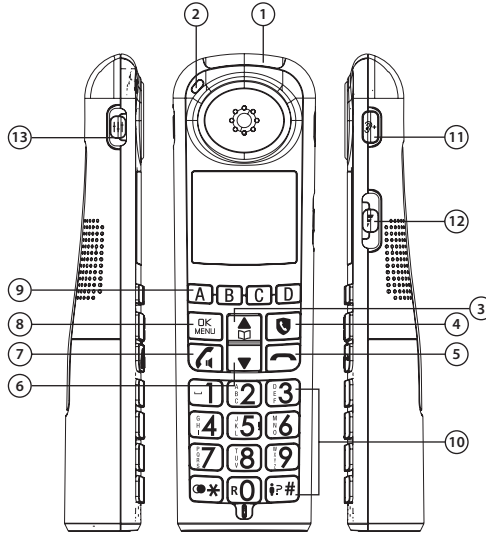

1. INCOMING CALL LED

- Flashes when there is an incoming call/ the base is paging the handset.

2. CHARGE LED

- On when the handset is charging in the charger.



- In menu mode: Press to scroll up the menu items.
- While entering names or numbers in the phonebook: Press to move the cursor to the left.
- In idle mode: Press to access phonebook.



- In Idle mode: Press to go to Call Block menu.
- In ringing mode: Press to block incoming call number if Block Set is set to ON.



- During a call: Press to end a call and go back to idle screen.
- In editing/predialing mode: Press to clear a character/digit.
- In menu/editing mode: Press and hold to go back to idle screen.
- In ringing: Press to suppress handset ringer.



- In menu mode: Press to scroll down the menu items.
- While entering names or numbers in the phonebook: Press to move the cursor to the right.



- In idle/pre-dialing mode: Press to make a call.
- During ringing: Press to answer a call.
- During a call: Press to turn on/off the speakerphone.



- Press to select a menu item.
- While in a menu: Press to select an item or save an entry or setting.

9. A B C D

- Press to dial out phone number stored in memory A, B, C, or D,...

10. ALPHANUMERIC KEYPAD/ * /

- In idle / pre-dial / editing mode / during a call: Press to enter characters /numbers.
- Press any key to answer an incoming call.
- During a call: Press and hold **R0** key to answer an incoming call when you receive a call waiting alert*.

11. AUDIO BOOST 

- During a call: Press to increase at lot the hearing volume in earpiece. 40dB at maximum.

 Warning: The product may emit high volume of sound. Take extra care when you use audio boost key, it is recommended to reduce volume at minimum level before pressing audio boost key.

12. 

- During a call: Press to increase the volume /decrease the volume (6 levels).

13. 

- Sound experience: select "NATURAL", "BASS" or "TREBLE" during a call.

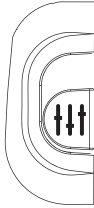

BASS (lowest position)

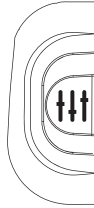

NATURAL
(mid position)



TREBLE (highest position)

14. 

- In idle mode. Long press to access the redial list. Short press for star.
- In talk mode. Only for star (access to local server services).

4.5. Menu tree of handset

MAIN MENU	Level 1	Level 2	Level 3	Level 4	Level 5
Call List	FIRST ENTRY	View	VIP X		
	Add To PB	VIP OK		
	LAST ENTRY	Add To Block	Confirm?		
		Delete	Confirm?		
Phonebook	All	DeleteAll	Add new	Number	Name
		FIRST ENTRY	Status		
		View		
		LAST ENTRY	Edit	Name	Number
			Delete	Confirm?	
			DeleteAll	Confirm?	
			Add to SD	KEY 1	
				KEY 2	
				
				KEY 9	
	Speed Dial	Key 1	Add new	Number	Name
		Key 2	View		
		Edit		
Call Block	Block Set	KEY 9	Delete	Confirm?	
		Off *	Saved		
		On	Saved		
		VIP OK	Saved		
	Blocklist	Contacts OK	Saved		
		FIRST ENTRY	Add new	Number	Name
		View		
		LAST ENTRY	Edit		
			Delete	Confirm?	Deleted
			Delete All	Confirm?	Deleted
	Block Anonym	Off *	Status	Used	
		Private	Saved		
		All	Saved		
			Saved		
Direct Mem.	A	Add new	Number	Name	
	..B...C..D	Voice Tag	Playback	Playing	
			Delete	Deleted	
			Record	Recording	
		View			
		Edit	Number	Name	
		Delete	Confirm?		
Ans.Machine	MSG Playback				
	Delete All	Confirm?			
		No Msg.			
	Memo	Recording			
		Playing			
	Tam On/Off	off			
		On*			
	OGM	Ans & Rec *	Play OGM	Playing	
			Rec. OGM	Recording	
			Delete	Deleted	
		Answer Only	Play OGM		
			Rec. OGM	Recording	
			Delete	Deleted	
	Answer Mode	Ans & Rec *			
		Answer Only	Play OGM		
	Tam Settings	BS Screening	Off *		
			On		
		Answer Delay	Rings 2		
			Rings 4		
			Rings 6 *		
			Rings 8		
			Rings 10		
		Record Time	60 s *		
			120 s		
			180 s		
		Remote Acc.	Off *		
			On		
		Change Pin	PIN?		
		Msg Alert	Off *		
			On		
		Language	English *		
			Francais		
			Deutsch		
			Italiano		
			Nederlands		
			Espanol		
			Portugues		
			Dansk		
			Svenska		

HS Setting	Ring Setup	Ext.Ring	Melody 1		
			Melody 2 *		
				
			Melody 12		
		Int.Ring	Melody 1		
			Melody 2		
			Melody 3 *		
				
			Melody 12		
		Ring Volume	Volume 1 *		
				
			Ring Off		
	Tone Setup	Key Tone	On *		
			Off		
		Batt. Tone	On *		
			Off		
		Out Of Area	On		
			Off *		
	Language	English *			
		Francais			
		Deutsch			
		Italiano			
		Nederlands			
		Espanol			
		Portugues			
		Dansk			
		Svenska			
	Date / Time	Date Format	DD-MM-YY *		
			MM-DD-YY		
		Time Format	24 HR *		
			12 HR		
			Set Date		
		Set Time			
	Auto Answer	On *			
		Off			
	Registration	Registration			
	Delete Hs	1234			
	Default	Confirm?			
Reminder	ALARM 1	On/Off	ON	Frequency	Once
	...ALARM 10		Off	Saved	Daily
					Mon-Fri
					Sat- Sun
		Melody	Melody 1		
				
			Melody 12		
		Rename	ALARM 1		
		Voice Tag	Playback	Playing	
			Record	Recording	
			Delete	Deleted	
Intercom	Handset x				
	Base				

5. USING YOUR PHONE

5.1. Set Date & Time and Language

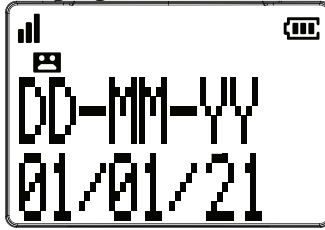

5.1.1. Set Date & Time

Through telephone base:

1. Choose **Menu**.
2. Press ▲ or ▼ to select **BS Setting**, then press **Ok**.
3. Press ▲ or ▼ to select **Date / Time**, then press **OK**.
4. Press ▲ or ▼ to select **Set Time**, then press **Ok**, input the day, month, year, then press **Ok**, input hour (24HR format), and minutes, then press **Ok**, you hear confirmation tones.
5. Press **R0** to select AM/PM (12HR format)

Note: if digit is input wrong during input Date or Time, you can press ▲ or ▼ to select the right position and input correct digit.

Through cordless handset:

1. Press **OK**_{MENU} on the handset in idle mode.
2. Press ▲ or ▼ to select **HS Setting**, then press **OK**_{MENU}.
3. Press ▲ or ▼ to select **Date / Time**, then press **OK**_{MENU}.
4. Press ▲ or ▼ to select **Set Date**, then press **OK**_{MENU}, input the day, month, year, then press **OK**_{MENU}, input hour (24HR format), and minutes, then press **OK**_{MENU}, you hear confirmation tones.
5. Press **R0** to select AM/PM (12HR format)

5.1.2. Change language

Through telephone base:

1. Choose **Menu** in idle mode.
2. Press ▲ or ▼ to select **BS Setting**, then press **Ok**.
3. Press ▲ or ▼ to select **Language**, then press **Ok**.
4. Select the desired language and press **Ok**. You hear confirmation tones.

Notes:

1. Base station has to be connected with AC mains during setting.
2. When language is changed, texts of LCD screen, talking digit, and default outgoing message of answering machine will be changed accordingly.

Through cordless handset:

1. Press **OK**_{MENU} on the handset in idle mode.
2. Press ▲ or ▼ to select **HS SETTING(1)**, then press **OK**_{MENU}.

(1)

EN	FR	DE	IT	NL	ES	PT
HS SETTING	REGL. COMB	MT-EINSTEL	IMP PORTAT	HS INST.	CONF SUPL	CONF TERM

3. Press ▲ or ▼ to select **LANGUAGE(2)**, then press **OK**.

(2)

EN	FR	DE	IT	NL	ES	PT
LANGUAGE	LANGUE	SPRACHE	LINGUA	TAAL	IDIOMA	IDIOMA

4. Select the desired language and press **OK**_{MENU}. You hear confirmation tones.

5.2. Make a Call

5.2.1. Preparatory Dialing

Through telephone base:

1. Enter the phone number and press **1** or lift up corded handset to dial the number.
2. Press **C** to clear entry number.

Through cordless handset:

1. Enter the phone number and press **1** to dial the number.
2. Press **C** to clear entry number.

5.2.2. Direct Dialing

Through telephone base:







Press  or lift up corded handset and enter the phone number.

Through cordless handset:









Press  to take the line and enter the phone number.

5.2.3. Call from the phonebook

Through telephone base:





1. Press  OR press **Menu** and  /  to select **Phonebook** then **Ok** to access the phonebook.
2. Press  /  to select the desired entry.
3. Press  or lift up corded handset to dial the entry.

Through cordless handset:

1. Press  OR press  and  /  to select **Phonebook** then  to access phonebook.
2. Press  /  to select the desired entry.
3. Press  to dial out the desired entry number.

5.2.4. Call from the Call List

Through telephone base:





1. Press and hold  key, OR press **Menu** and  /  to select **Call List** then **Ok** to access Call List.
2. Press  /  to select the desired entry.
3. Press  or lift up corded handset to dial the entry.

Through cordless handset:





1. Press and hold **#** key, OR press  and  /  to select **Call List** then  to access Call List.
2. Press  /  to select the desired entry.
3. Press  to dial the entry.

5.2.5. Call from the redial list

Through telephone base:

1. Press  key to access the redial list.
2. Press  /  to select the desired entry.
3. Press  or lift up corded handset to dial the entry.

Through cordless handset:

1. Press and hold  key to access the redial list.
2. Press  /  to select the desired entry.
3. Press  to dial the entry.

5.2.6. Call direct memories (A, B, C, D) on base or on handset (same memories)

Press  (on handset) or  (on base) to enter talk mode.

Press again if you wish to activate handsfree mode.

Press **A, B, C, D** key on handset or Photo **A, B, C, D** key on base to dial.

Note:

- Pressing  or  a third time will terminate handsfree mode.
- Before dialing, programming of **A, B, C, D** keys is required, refer to Section 6.3.

5.2.7 Call the indirect memories (Key 1 to Key 9)

Long press Key 1, or, ...Key 9 to dial.

Note: Before dialing, programming of key 1, ...key 9 is required, refer to Section 11.5.

5.3. Answer a Call

Through telephone base:

Press  to answer a call. The handsfree mode will be activated or lift up corded handset to answer.

Through cordless handset:

If the handset is not on the charging cradle, when the phone rings, press .

5.4. End a Call

During a call,

Through telephone base:

Press  or put back corded handset to end the call.

Through cordless handset:

Press , OR place the cordless handset on the charging cradle to end the call.

5.5. Set Photo A, B, C, D key memories

5.5.1. Input number and name





A, B, C, D memories are shared by base and handset (same memories). Once a direct memory is registered, it is automatically copied on the other appliance (base or handset).

Through telephone base:

1. Press **Menu** in idle mode.
2. Press ▲ or ▼ to select **Direct Mem.**, then press **Ok**.
3. Press ▲ or ▼ to select **A, B, C, D**, then press **Ok**.
4. Select **Add new**, then press **Ok**, enter the telephone number, then enter the name, then press **Ok**. You hear confirmation tones.

Note: during entering number or name, you can correct a number or a letter by pressing **BACK**, then last number or letter will be removed.

Through cordless handset:

1. Press  on the handset in idle mode.
2. Press ▲ or ▼ to select **Direct Mem.**, then press .
3. Press ▲ or ▼ to select **A, B, C, D**, then press .
4. Select **Add new**, then press , enter the telephone number, then enter the name, then press . You hear confirmation tones.

Note: during entering number or name, you can correct a number or a letter by pressing , then last number or letter will be removed.

5.5.2. Record your own voice tag

This feature requires a subscription of Caller Line Identification service from your telephone service provider. This feature is VERY convenient to know who calls you if his/her telephone number is stored and voice is recorded in 1 of 4 photo keys.





You can program telephone number and record your voice through the handset.

For other operations, they are controlled through the handset only.



Through telephone base:

1. Continue section 5.5.1., press **Ok**.
2. **View** appears, press ▲ or ▼ to select **Voice Tag**, then press **Ok**.
3. Press ▲ or ▼ to select **Record**, then press **Ok**.
4. **Recording...** will appear, then you can speak (better with louder voice) after beep tone in front of handset microphone area.
5. Press **Ok** to finish recording.
6. Your recorded voice will be playback automatically.

Through cordless handset:

1. Continue section 5.5.1., press .
2. **View** appears, press ▲ or ▼ to select **Voice Tag**, then press .
3. Press ▲ or ▼ to select **Record**, then press .
4. **Recording...** will appear, then you can speak (better with louder voice) after beep tone in front of handset microphone area (near key 0).
5. Press  to finish recording.
6. Your recorded voice will be playback automatically.

Note: 15 seconds approx. recording time per memory.

When calling number matched to photo **A, B, C, D** ringing sound with recorded voice will be announced from handset and base until you press  on handset or  on base to answer.

5.5.3. Play Voice tag

Through telephone base:

1. Press **Menu** in idle mode.
2. Press ▲ or ▼ to select **Direct Mem.**, then press **Ok**.
3. Press ▲ or ▼ to select **A, B, C, D**, then press **Ok**.
4. **View** appears, press ▲ or ▼ to select **Voice Tag**, then press **Ok**.
5. **Playback** appears, then press **Ok**.
6. **Playing...** will appear. The recorded voice will be playback.

Through cordless handset:

1. Press **OK**_{MENU} on the handset in idle mode.
2. Press **▲** or **▼** to select **Direct Mem.**, then press **OK**_{MENU}.
3. Press **▲** or **▼** to select **A, B, C, D**, then press **OK**_{MENU}.
4. **View** appears, then press **▲** or **▼** to select **Voice Tag**, press **OK**_{MENU}.
5. **Playback** appears, then press **OK**_{MENU}.
6. **Playing...** will appear. The recorded voice will be playback.

5.5.4. Delete Voice tag

Through telephone base:

1. Repeat the step 1 to 4 in Section 5.5.3.
2. **Playback** appears, then press **▲** or **▼** to select **Delete**, press **Ok**.

Through cordless handset:

1. Repeat the step 1 to 4 in Section 5.5.3.
2. **Playback** appears, then press **▲** or **▼** to select **Delete**, press **OK**_{MENU}.
3. **Empty** will display. You hear confirmation tones.

5.5.5. View record of Photo memory

Through telephone base:

1. Press **Menu** in idle mode.
 2. Press **▲** or **▼** to select **Direct Mem.**, then press **Ok**.
 3. Press **▲** or **▼** to select **A, B, C, D**, then press **Ok**.
 4. **View** appears, then press **Ok**.
 5. Record (number) will show.
- Press **Back** to return previous menu.

Through cordless handset:

1. Press **OK**_{MENU} on the handset in idle mode.
 2. Press **▲** or **▼** to select **Direct Mem.**, then press **OK**_{MENU}.
 3. Press **▲** or **▼** to select **A, B, C, D**, then press **OK**_{MENU}.
 4. **View** appears, then press **OK**_{MENU}.
 5. Record (name and number) will show.
- Press **↶** to return previous menu or long press **↶** to return to standby mode.

5.5.6. Edit record of Photo memory

Through telephone base:

1. Press **Menu** in idle mode.
 2. Press **▲** or **▼** to select **Direct Mem.**, then press **Ok**.
 3. Press **▲** or **▼** to select **A, B, C, D**, then press **Ok**.
 4. **View** appears, then press **▲** or **▼** to select **Edit**, then press **Ok**.
 5. Edit number, then press **Ok**.
 6. Edit name, then press **Ok**.
- Press **Back** to return previous menu.

Note: during entering number or name, you can correct a number or a letter by pressing **C**, then last number or letter will be removed.

Through cordless handset:

1. Press **OK**_{MENU} on the handset in idle mode.
 2. Press **▲** or **▼** to select **Direct Mem.**, then press **OK**_{MENU}.
 3. Press **▲** or **▼** to select **A, B, C, D**, then press **OK**_{MENU}.
 4. **View** appears, then press **▲** or **▼** to select **Edit**, then press **OK**_{MENU}.
 5. Edit number, then press **OK**_{MENU}.
 6. Edit name, then press **OK**_{MENU}.
- Press **↶** to return previous menu or long press **↶** to return to standby mode.

Note: during entering number or name, you can correct a number or a letter by pressing **↶**, then last number or letter will be removed.

5.5.7. Adjust Earpiece and Handsfree Volume

There are 6 levels to choose from for earpiece volume in Cordless handset and handsfree volume, through volume slide switch (refer to Section 4.1 and 4.3).

During a call:

Through telephone base:

Slide left and right  to select volume 1-6.

Through Cordless Handset:

Slide up and down  to select volume 1-6.

The current setting is shown in LCD.

5.6. Audio Boost

Use the audio boost feature to enhance the clarity and loudness of your caller's voice on the cordless handset earpiece or combo handset ear piece when you are listening to a message or an announcement.

To turn on Audio Boost:

While you are on a call or listening to a message or an announcement using the handset earpiece.

Using cordless handset, press + on side of handset or

Using combo handset, press + on left front side of base.

To turn off Audio Boost:

Press + on side of handset or on front left side of combo base again.



Note: Audio boost function will be off after end of call.

 Warning: The product may emit high volume of sound. Take extra care when you use audio boost key, it is recommended to adjust suitable volume by setting minimum, and then turn on audio boost key.

5.7. Equalizer

The equalizer feature on the handset enables you to change the quality of the handset audio to best suit your hearing.

During a call:





Slide up and down  on handset or  on combo base to select Treble, Natural, or Bass.(refer to Section 4.4 item 13 (cordless handset) and Section 4.1 item 12 (for Xtra 3355 combo base) for details).

5.8. Redial

Each cordless handset stores the last 10 dialled numbers (up to 17 digits each) in the redial list. The redial entries are shared by all the system handsets.





Through Telephone Base:

In idle mode:

1. Press * and hold for more than 2 seconds (long press).
2. Press  or  repeatedly to browse the list. The base beeps twice at the end of the list.
3. When the desired entry displays, lift the corded handset or press  to dial.

Through cordless handset:

In idle mode:

1. Press * and hold for more than 2 seconds (long press).
2. Press  or  repeatedly to browse the list. The handset beeps twice at the end of the list.
3. When the desired entry displays, press  to dial (or twice to call in speaker mode).



6. PHONEBOOK

The phonebook stores up to 100 entries, which are shared by all handsets.











6.1. Add a New Phonebook Entry

In idle mode,

Through telephone base:

1. Press **Menu** and  or  to select **Phonebook**, then press **Ok** to access the phonebook list. ALL appears and press **Ok**. Press **Menu**, then select **Add new** and press **Ok**. Enter a telephone number, press **Ok**. Enter a name, then press **Ok**. You hear confirmation tones.

Through cordless handset:



1. Press  or,
2. Press  , press  to select **Phonebook**, then press  to select **All**, press .
3. Press  **Add new** appears press .
4. Enter a telephone number, press .
5. Enter a name, then press . You hear confirmation tones.

6.2. View a Phonebook Entry

Through telephone base:

1. Select a desired entry in the phone book, and then press **Menu**.
2. **Add new** appears then press ▲ or ▼ to select **View**, press **Ok** to review name and number of the entry.
3. Press **Back** to return previous menu.

Through cordless handset:

1. Select a desired entry in the phone book, and then press ^{OK}_{MENU}.
2. **Add new** appears then press ▲ or ▼ to select **View**, press ^{OK}_{MENU} to review name and number of the entry.
3. Press  to return previous menu or long press  to return to standby mode.

6.3. Search a phonebook entry

1. Follow the steps in View a phonebook entry above to enter the phonebook.
2. Enter the first character of the name to search.

6.4. Edit a Phonebook Entry

Through telephone base:

1. Select a desired entry in the phone book, and then press **Menu**
 2. **Add new** appears then press ▲ or ▼ to select **Edit**, press **Ok** to edit number of the entry.
 3. Press **Ok** to edit the name. You hear confirmation tones.
- Note: during entering number or name, you can correct a number or a letter by pressing **Clear**, then last number or letter will be removed.

Through cordless handset:

1. Select a desired entry in the phone book, and then press ^{OK}_{MENU}.
 2. **Add new** appears then press ▲ or ▼ to select **Edit**, press ^{OK}_{MENU} to edit the number.
 3. Press ^{OK}_{MENU} to edit the name. You hear confirmation tones.
- Note: during entering number or name, you can correct a number or a letter by pressing , then last number or letter will be removed.

6.5. Store phonebook in speed dial

Through telephone base:

1. Select a desired entry in the phone book, and then press **Menu**.
2. **Add new** appears then press ▲ or ▼ to select **Add to SD**, press **Ok**.
3. Press ▲ or ▼ to select **Key 1** to **Key 9**.
4. Press **Ok** to confirm. You hear confirmation tones.

Through cordless handset:

1. Select a desired entry in the phone book, and then press ^{OK}_{MENU}.
2. **Add new** appears then press ▲ or ▼ to select **Add to SD**, press ^{OK}_{MENU}.
3. Press ▲ or ▼ to select **Key 1** to **Key 9**.
4. Press ^{OK}_{MENU} to confirm. You hear confirmation tones.

6.6. Delete a Phonebook Entry

Through telephone base:

1. Select a desired entry in the phone book, and then press **Menu**.
2. **Add new** appears then press ▲ or ▼ to select **Delete**, press **Ok**.
3. **Confirm?** will display, press **Ok** to confirm. You hear confirmation tones

Through cordless handset:

1. Select a desired entry in the phone book, and then press ^{OK}_{MENU}.
2. **Add new** appears then press ▲ or ▼ to select **Delete**, press ^{OK}_{MENU}.
3. **Confirm?** will display, press ^{OK}_{MENU} to confirm. You hear confirmation tones.

6.7. Add to speed dial key

Through telephone base:





1. Select a desired entry in the phone book, and then press **Menu**.
2. **Add new** appears then press ▲ or ▼ to select **Add to SD**, press **Ok**.
3. Press ▲ or ▼ to select **Key 1, ... Key 9**, press **Ok** to confirm. You hear confirmation tones.

Through cordless handset:

1. Select a desired entry in the phone book, and then press ^{OK}_{MENU}.
2. **Add new** appears then press ▲ or ▼ to select **Add to SD**, press ^{OK}_{MENU}.
3. Press ▲ or ▼ to select **Key 1, ... Key 9**, press ^{OK}_{MENU} to confirm. You hear confirmation tones.

6.8. Status of phonebook





You can view how many phonebook records are stored out of total 100 records. Through both Cordless Handset and Telephone Base:

1. Press , press .
2. **Add new** appears then press  or  to select **Status**, press **Ok**.
3. **X / 100 Used** will display.

7. PHONE SETTINGS

7.1. Set Ringer Melody and Volume

For Telephone base:

1. Press **Menu** and  or  to select **BS Settings**, then press **Ok**.
2. And  or  to select **BS Ringer**, then press **Ok**.
3. After selection, press to confirm setting. You hear confirmation tones.

Notes:

Ext. Ring means ring tone (total 12 for handset, 12 for base) will ring when external call.









Int. Ring means ring tone (total 12 for handset) will ring when internal call (between base and handset, or among 2 or more handsets registered to the base).

Ring Vol is for: **Off** (ringer is off), **Volume 1 to Volume 5**.

When the telephone is ringing, you can temporarily set silence for the ringer of the handset by pressing  only without disconnecting the call.













The next call rings normally at the preset volume.

For cordless handset:

1. Press  on the handset in idle mode.
2. Press  or  to select **HS Setting**, then press .
3. Select **Ring Setup** by pressing .
4. Press  or  to select **Ext. Ring**, **Int. Ring** or **Ring Volume**, then press .
5. After selection, press  to confirm setting. You hear confirmation tones.











7.2. Set Alert Tone

You can turn on the alert tone in the cordless handset when low battery/out of range is detected and key tone can be on or off.















1. Press  when idle.
2. Press  or  to select **HS Setting**, then press .
3. Press  or  to select **Tone Setup** then press .
4. Press  or  to select **Key Tone**, **Batt. Tone**, or **Out Of Range**, then press .
5. Press  or  to select **On** or **Off**, then press . You hear confirmation tones.

7.3. Set the Date and Time

Through telephone base:



1. Press **Menu** and  or  to select **BS Settings**.
2. Press **Ok** and  or  to select **Date/Time**.
3. Press **Ok** and  or  to select **Date Format**.
4. Press **Ok** and  or  to select your desired date format (**DD-MM-YY** or **MM-DD-YY**) or Press  or  to select **Time Format**, then press , select your desired time format (**24HR** or **12HR**).
5. Press **Ok** to confirm.

Through cordless handset:

1. Press  when idle.
2. Press  or  to select **HS Settings**, then press .
3. Press  or  to select **Date/Time**, then press .
4. Press  or  to select **Date Format**, then press , select your desired date format (**DD-MM-YY** or **MM-DD-YY**), OR
5. Press  or  to select **Time Format**, then press , select your desired time format (**24HR** or **12HR**).
6. Press  to confirm. You hear confirmation tones.

7.4. Talking Digit

You can turn on or off the audible spoken tone that is spoken when you press the dialing key on handset and Base during predialing during a call.

1. Press **Menu** when idle.
2. Press  or  to select **Talk Digit**, then press **Ok** to select **On** or **Off**.
3. Press **Ok** to confirm. You hear confirmation tones.

Note: spoken language of talking digit is same as what language has been in selected Section 5.1.2.

7.5. Change the Flash Time

Through telephone base:

1. Press **Ok** when idle.
2. Press ▲ or ▼ to select **BS Setting**, then press **Ok** .
3. Press ▲ or ▼ to select **Flash Time**, then press **Ok** .
4. Press ▲ or ▼ to select your desired flash time.
(**Short, Medium, Long** are for your selection), then press **Ok** to confirm. You hear confirmation tones.

7.6. Reset Your Phone

You can reset your phone to the default settings by using handset.

After reset, all your personal settings will be deleted and resumed to default factory settings, but your phonebook and other memories remain unchanged except redial list.

Through telephone base:

1. Press **Menu** when idle.
2. Press ▲ or ▼ to select **BS Setting**, then press **Ok**.
3. Press ▲ or ▼ to select **Default**, then press **Ok, Confirm?** Is displayed, then press **Ok** to confirm. You hear confirmation tones.



Through cordless handset:

1. Press  when idle.
2. Press ▲ or ▼ to select **HS Setting**, then press .
3. Press ▲ or ▼ to select **Default**, then press , **Confirm?** Is displayed, then press  to confirm. You hear confirmation tones.

8. Registration Cordless Handset to Telephone Base

8.1. Registration

Your handset and telephone base is pre-registered. If for some reason, the handset is not registered to the base station, **Put On BS** will be displayed on the handset screen. If it is out of base and ■■■ disappears on the screen, register your handset according to the following procedure.

1. Make sure the handset is out of the base and shows **Put On BS** before you begin registration.
2. Press and hold **Page** on the telephone base in idle mode for around 5 seconds until incoming call light LED bar lits on the telephone base.
3. Press  on handset when idle.
4. Press ▲ or ▼ to select **HS SETTING**, then press .
5. Press ▲ or ▼ to select **Registration**, then press , **Registration** appears on the screen until the handset displays Registered.

If registration fails, the handset displays **Impossible**.

Please repeat the above procedure.

8.2. Locate the Cordless Handset

To locate the handset: On the base, press the key located under PAGE (on display) once.

All the handsets registered to the base will produce the paging tone and "**Paging**" is displayed on the LCD of the handsets and on the base display.



You can stop the paging by pressing , , on any handset or **Page** on the base again.

Note: If there is an incoming call during paging, the phone will ring with the incoming call instead of paging.



8.3. Conference Call

Up to 4 cordless handsets and the telephone base can join an external call at the same time.

To join a call with the telephone base:

- Press  to join the call,
- Press  again, to exit the call.
- Lift up the Corded handset to join, and return to cradle to exit.

To join a call with a cordless handset:



- Press  join the call.
- Press  or place the handset in the base or charger to exit the call.

8.4. Transfer a call

During an external call, you can transfer the call from a cordless handset or the telephone base to another system device.











To transfer a call from the telephone base:

During a call,

1. If the handset(s) is put in base or charger, just take it away from cradle, the call will be transferred from base to handset automatically.
2. If handset(s) is out of base or charger, press  to start conference call among base and external call. Then, press  on the base to transfer the call to the handset.

To transfer a call from a cordless handset:







During a call,

1. Press  then press  or  to select **Intercom**, then press .
2. If you have two or more cordless handsets, press  or  to select the desired device and then press .
3. The external call is put on hold and the cordless handset shows **Call from Handset 2** or **Call from Base** destination device rings.
4. To answer the call on the destination handset, press , or any dialing key,
OR,
To answer the call on the base, press  (speaker mode) OR, lift up the corded handset.
5. Press  on the calling handset to transfer the call to extra handset or base.











8.5. Intercom

Use the intercom feature for conversations between two cordless handsets or between cordless handset and base. In idle mode,

Intercom initiated from telephone base

1. Press **Menu** , and then press  or  to select **Intercom**, then press **Ok**.
2. If you have two or more cordless handsets, press  or  to select the desired device and then press **Ok**.
3. The handset shows **Call from Handset 2**, the destination device rings.
4. To answer the call on the destination handset, press , or any dialing key.
OR, To answer the call on the base, press  (speaker mode) OR ,lift up the Corded handset to join,and return to cradle to exit.

Intercom initiated from cordless handset

1. Press , and then press , then press  or  to select **Intercom**, then press .
2. If you have two or more cordless handsets, press  or  to select the desired device and then press .
3. The cordless handset shows **Call from Handset 2**, the destination device rings.
4. To answer the call on the destination handset, press , or any dialing key,
OR, To answer the call on the base, press  (speaker mode).

8.6. Answer a Call / Auto Answer (Cordless handset only)







If the handset is not on the charging cradle:

When the phone rings, press  to answer a call.

If the handset is on the Charging cradle and if **Auto Answer** is set to ON:

When the phone rings, pick up the handset directly to answer a call. It is not needed to press the  key.

To set the **Auto Answer** on:

1. Press **OK** when idle.
2. Press  or  to select **HS Setting**, then press **Ok**.
3. Press  or  to select **Auto Answer**, then press **Ok**.
4. Press  or  to select **On**.
5. Press **Ok** to confirm. You hear confirmation tones.
6. To answer the call on the base, press  (speaker mode), OR, lift up the Corded handset to join,and return to cradle to exit.

8.7. Enriched ringer

When first call is not picked up and the same caller calls again within 5 minutes, the ringer level of handset and base will be automatically set to maximum, in order to alert elderly people or people far from the telephone that the phone is ringing.

To enable enriched ringer:

1. Press **Menu**
2. Press **▲** or **▼** to select **BS Setting**, then press **Ok**.
3. Press **▲** or **▼** to select **Enriched Ringer**, then press **Ok** to select **On**.
4. Press **Ok** to confirm. You hear confirmation tones.

To disable enriched ringer:

1. Repeat the above item to 1 to 2.
2. Press **▲** or **▼** to select **Enriched Ringer**, then press **Ok** to select **Off**.
3. Press **Ok** to confirm. You hear confirmation tones.

9. REMINDER

The reminder feature helps remind you of important events. You can set the reminder to record your voice, or use alarm sound in order to remind you only once, or in daily, Monday to Friday or Saturday to Sunday. Once you set the reminder, the system will alarm you at the alarm time. Each reminder can be up to 2 minutes in length.

NOTE: All the procedures described below can also be performed from the telephone base. From there, the only difference is that the icon  described below corresponds to the telephone base key.

9.1. Turn on alarm reminder, set time and frequency

Through both cordless handset and telephone base:

1. Press **Ok** when idle.
2. Press **▲** or **▼** to select **Reminder**, then press **Ok**.
3. Press **▲** or **▼** to select **Alarm 1.. Alarm 10**, then press **Ok**.
4. **On/Off** appears then press **Ok** to select **On**.
5. Enter the time then press **Ok**.
6. Press **▲** or **▼** to select frequency **Once, Daily, Mon-Fri, Sat-Sun**.
7. Press **Ok** to confirm. You hear confirmation tones.

9.2. Select melody of the alarm reminder



1. Repeat step 1 to 3 in Section 9.1.
2. **On/Off** appears then press **▼** to select **Melody**, press **Ok**.
3. Press **▲** or **▼** to select desired melody.
4. Press **Ok** to confirm. You hear confirmation tones.

9.3. Rename the alarm reminder

1. Repeat step 1 to 3 in Section 9.1.
2. **On/Off** appears then press **▼** to select **Rename**, press **Ok**.
3. Change name from **Alarm** to the name you desire. (max. 9 letters or digits)
4. Press **Ok** to confirm. You hear confirmation tones.

Note: during entering number or name, you can correct a letter by pressing , then last number or letter will be removed.

9.4. Record Voice memo of the alarm reminder

1. Repeat step 1 to 3 in Section 9.1.
2. **On/Off** appears then press **▼** to select **Voice Tag**, press **Ok**.
3. **Playback** appears then press **▼** to select **Record**, press **Ok** to start recording.
4. **Recording...** appears after beep sound, you can record your voice.
5. Press **Ok** to finish your voice recording. Your voice will replay.
6. Press  to return previous menu or long press  to return to standby mode.

Notes:

1. You can playback your memo voice in step 3 to select **Playback**, then press **Ok**. **Playing** will appear.
2. You can delete your memo voice in step 3 to select **Delete**, press **Ok**. Then, **Delete** will appear after the memo is deleted.
3. If no voice memo in the alarm reminder, only melody will play for 2 minutes at the alarm time.
4. **Ok** in the first step is replaced by MENU for telephone base: **Back** is used to correct a letter/ to return previous menu.

10. SPEED DIAL KEYS (KEY 1 TO KEY 9)

You can make use of key 1 to key 9 on handset as speed dial keys, by long pressing it to dial in idle mode or in talk mode.

10.1. Store a speed dial entry

Through telephone base:

1. Press **Menu**, press ▼ to select **Phonebook**, then press **Ok**.
2. Press ▼ to select **Speed Dial**, press **Ok**.
3. Press ▲ or ▼ to select **Key 1,... Key 9**, then press **Menu**.
4. **Add new** will display, then press **Ok**.
5. Enter a number, then press **Ok**.
6. Enter a name, then press **Ok**. You hear confirmation tones
7. Press **Back** to return previous menu.

Through cordless handset:

1. Press ^{OK}_{MENU}, press ▼ to select **Phonebook**, then press ^{OK}_{MENU}.
2. Press ▼ to select **Speed Dial**, press ^{OK}_{MENU}.



3. Press ▲ or ▼ to select **Key 1,... Key 9**, then press ^{OK}_{MENU}.
4. **Add new** will display, then press ^{OK}_{MENU}.
5. Enter a number, then press ^{OK}_{MENU}.
6. Enter a name, then press ^{OK}_{MENU}. You hear confirmation tones.
7. Press to return previous menu or long press to return to standby mode.

10.2. View a speed dial entry

Through both cordless handset and telephone base

1. Repeat the step 1 to 3 in Section 10.1.
2. **View** will display, then press **Ok**.
3. The record (number and name) can be viewed.

Press / **Back** to return previous menu or long press to return to standby mode.

10.3. Edit a speed dial entry

Through both cordless handset and telephone base

1. Repeat the step 1 to 3 in Section 10.1.
2. **View** will display, then press ▲ or ▼ to select **Edit**, then press **Ok**.
3. Edit a number, then press **Ok**.
4. Edit a name, then press **Ok**. You hear confirmation tones.

Note: during entering number or name, you can correct a number or a letter by pressing , then last number or letter will be removed.

10.4. Delete a speed dial entry

Through both cordless handset and telephone base

1. Repeat the step 1 to 3 in Section 10.1.
2. **View** will display, then press ▲ or ▼ to select **Delete**, then press **Ok**.
3. **Confirm?** will display, then press **Ok**. You hear confirmation tones.



11. CALLER DISPLAY (network dependent)

This feature is available if you have subscribed the Caller Line Identification service with your telephone service provider.

Your phone can store up to 100 received calls with date/time information in the Call List. The number will be shown on the LCD when the phone is ringing. If the number matches with one of the entries in your Private Phonebook, the caller's name stored in the private phonebook will be displayed with the number.

If the caller number is disabled to send caller information, **Unknown** will display.

If the caller number is not provided, **Private** will display.

In standby, if three unanswered calls with different calling number are received, "3 New Calls" will be displayed. Each time you review a call list entry marked with  icon, the number of new calls decreases by one. When you have reviewed all the new calls, the  icon no longer shows.





If the incoming telephone number matches the last 7 digits of a telephone number in your phonebook, the name that appears on the screen matches the corresponding name in your phonebook.

11.1. View the Call List











All received calls are saved in Call List with the latest call putting at the top of the list. When the call list is full, the oldest call will be replaced by a new call. The latest call log is stored only when it is same calling number. When number of digits of incoming number is more than 10, it will show first 9 digits in first page, then, you can press ***** key to view all digits.

In idle mode,

Through telephone base:



1. Press  key, or Press **Menu** and  or  to select **Call List**.
2. Press **OK**, the call list will be shown. The unanswered call which has not been read is marked with a ***** at the end of the number.
3. Press  or  to select the desired entry.
4. Press **OK**, to see more detail information of the desired entry.

Through cordless handset:







1. Press , then press  or  to select **Call List**, then press  to review the calling number display history.
2. Press  or  to browse the call log.
3. Press , **View** will show.
4. Press  to view the details of the call log including date and time. (Date/Month and Time appears in left and right sides of lower row respectively)
5. Press  to return previous menu or long press  to return to standby mode.

11.2. Store a Call List Number into the Phonebook

Through telephone base:



1. Select a desired entry in the call list, and then press **Ok**.
2. Press **Ok** and  or  to select **Add To PB**.

Through cordless handset:







1. Select a desired entry in the call list, and then press .
2. Press  or  to select **Add To PB**, and then press .
3. Call number appears press  to confirm.
4. Call name appears if there is blank name, you can add the name.
5. Press  to confirm. You hear confirmation tones.

11.3. Store a Call List Number into the Black List

Through telephone base:

1. Select a desired entry in the call list, and then press **Ok**
2. Press  or  to select **Add To Block**, and then press **Ok**.
3. Call number appears press **Ok** to confirm.
4. Call name appears if there is blank name, you can add the name.
5. Press **Ok** to confirm. You hear confirmation tones.

Through cordless handset:

1. Select a desired entry in the call list, and then press .
2. Press  or  to select **Add To Block**, and then press .
3. Call number appears press  to confirm.
4. Call name appears if there is blank name, you can add the name.
5. Press  to confirm. You hear confirmation tones.

11.4. Delete an entry in the Call List

Through telephone base:

1. Select a desired entry in the call list, and then press **Ok**.
2. Press **Ok** and ▲ or ▼ to select **Delete**.
3. **Confirm?** will show, press **Ok** to confirm. You hear confirmation tones.
4. Repeat steps 3 in part 5.2.4.

Through cordless handset:

1. Select a desired entry in the call list.
2. Press ▲ or ▼ to select **Delete**, and then press **OK**_{MENU}.
3. **Confirm?** appears press **OK**_{MENU} to confirm. You hear confirmation tones.

11.5. Delete the entire list of the Call List

Through telephone base:

1. Select a desired entry in the call list.
2. Press **Ok** and ▲ or ▼ to select **Delete All**.
3. **Confirm?** will show.
4. Press **Ok**. You hear confirmation tones.

Through cordless handset:

1. Select a desired entry in the call list.
2. Press ▲ or ▼ to select **Delete All**, and then press **OK**_{MENU}.
3. **Confirm?** will show, Press **OK**_{MENU} to confirm. You hear confirmation tones.

11.6. Call Waiting

You hear a tone in the handset earpiece if someone calls while you are already on a call.

Using handset or speaker mode from the combo base

- Long press **R** key on combo base to put your current call on hold and take the new call.
- Long press **R** key on combo base to switch back and forth between calls.

Using handset or speaker mode from the handset

- Long press **R** key on cordless handset to put your current call on hold and take the new call.
- Long press **R** key on cordless handset to switch back and forth between calls.

12. CALL BLOCK

This telephone is built-in with Smart Call Block feature*. This feature will help you avoid nuisance calls by only allowing some numbers to make your phone ring.

*This feature requires a subscription of *Caller Line Identification service* from your telephone service provider

CALL BLOCK OVERVIEW

Setting	Explanations
Off	Call Block function (Block all call with numbers) is Disabled. This is the default mode.
On	Call Block function is set to Manual. Numbers registered in the black list will not go through and the phone will ring silently. Numbers can be added to the list while the phone is ringing and / or after a call (to enable, see part 12.1).
Contacts	In this automatic mode, any number not registered to your phonebook will be automatically be blocked and not cause your phone to ring. All calls from contacts registered to your phonebook will proceed normally. When this mode is chosen, Contacts OK is displayed on LCD in idle mode unless you have unread messages/missed calls (to enable, see part 12.6.2).
VIP	In this second automatic mode, only calls from contacts registered as VIP in your phonebook will go through and cause your phone to ring. Any other number will not ring. When this mode is chosen, VIPS OK is displayed on the LCD in idle mode unless you have unread messages / missed calls (to enable, see part 12.6.2).
ANONYMOUS	This extra feature allows you to block call that do not have a number attached to them (ie private calls, international calls, etc). This option can be enabled on top of any of the previous four (to enable, see part 12.7).

12.1. Manual call block mode

Manual call block is the easiest option when starting out. When you chose ON in the call block settings, all calling numbers registered in your blacklist will be blocked. You can add/remove numbers from that list at any time.

How to block an incoming call:

When the phone is ringing and before answering, press . It will terminate the call and offer you the option to register the number to the blacklist in one click. Then to confirm the registration of this number in the blacklist, press **Ok**.

IMPORTANT: if you don't confirm, the number will not be added to the blacklist and the next call will go through normally.

NOTE: All the procedures described below (to 12.1.1 to 12.8) can also be performed from the telephone base. From there, the only difference is that the icon / described below corresponds to the telephone base key.

12.1.1. Enable MANUAL mode

Menu		Call block		Block set.	Off
					On*
					VIP OK
					Contacts OK

In idle mode,

Press , press or to select **Call Block**.

Press , press or to select **Block Set**.

Press , press or to select **On** (manual mode).

OR

In idle mode, press to access **Block Set**. directly.

After you enable this option, the call block icon will be displayed on the LCD.

12.2. Add numbers to Blocklist

In idle mode,

1. Press key, **Call Block** and its icon is displayed, then press or to select **Blocklist**, press to show Blocklist numbers.

2. Press or to select numbers stored in **Blocklist**.

3. Press to select **Add new**, enter number to be blocked, press to save.

NOTE: 1 more ways to add incoming and outgoing call numbers in Block list:

1. From incoming call numbers

Press , to enter Call list, press or to select the stored numbers in **Call List**.

Press **Menu**, press or to select the **Add to Block**.

Press **Ok** to show selected number, press to save to Block list.

12.3. Edit numbers in Block List

In idle mode,

1. Repeat step 1 and 2 in Section 12.2. to select the stored numbers.

2. Press , press or to select **Edit**, start to edit selected number press to save.

12.4. Delete a number in Blocklist

1. Repeat step 1 and 2 in Section 12.2. to select the stored numbers.

2. Press , press or to select **Delete, Confirm?** is shown, and then press to confirm.

12.5. Delete all numbers from Blocklist

1. Repeat step 1 and 2 in Section 12.2. to select the stored numbers.

2. Press , press or to select **Delete All** to delete at a time, press , **Confirm?** is shown, and then press to confirm.

12.6. Automatic call block mode

12.6.1. VIPS only

In this restrictive automatic mode, only calls from numbers registered as VIP in your phonebook will go through and make your phone ring.

Menu	↑ ↓	Call block	↑ ↓	Block set.	Off
					On
					VIP OK*
					Contacts OK

1. Press OK_{MENU} , press ▲ or ▼ to select **Call Block**.
2. Press OK_{MENU} , press ▲ or ▼ to select **Block set**.
3. Press OK_{MENU} , press ▲ or ▼ to select **VIP OK** (Automatic mode).

12.6.2. Contacts only

In this broad automatic mode, only calls from contacts registered in your phonebook (normal and VIP) will go through and make your phone ring.

Through cordless handset:

Menu	↑ ↓	Call block	↑ ↓	Block set.	Off
					On
					VIP OK
					Contacts OK*

1. Press OK_{MENU} , press ▲ or ▼ to select **Call Block**.
2. Press OK_{MENU} , press ▲ or ▼ to select **Block Set**.
3. Press OK_{MENU} , press ▲ or ▼ to select **Contacts OK** (Automatic mode).

12.7. Anonymous call block mode

This feature allows you to block numbers that do not display a number on your phone. It can be enabled or disabled independently from the previous call block modes.

Menu	↑ ↓	Call block	↑ ↓	Block anonym	Private*
					All
					Off

1. Press OK_{MENU} , press ▲ or ▼ and press OK_{MENU} to select **Call Block**.
2. Press ▲ or ▼ to select **Block Anonym**.
3. Press OK_{MENU} , press ▲ or ▼ to select one of the options.

12.7.1. Block Private Calls

This mode will block incoming calls that have been purposely kept their numbers private from you.

In idle mode,

1. Press OK_{MENU} key, Call block and its icon is displayed.
2. Press ▲ or ▼ to select **Block Anonym**.
3. Press OK_{MENU} , press ▲ or ▼ to select **Private**, press OK_{MENU} to confirm.
4. Press Back twice.
5. OK_{MENU} will be displayed on the upper side of LCD.

12.7.2. Block All Anonymous Calls

This mode will block all unknown incoming calls, including private calls, international calls, pay phone and other out-of-area calls.

In idle mode,

1. Repeat step 1 and 2 in Section 12.7.1.
2. Press OK_{MENU} , press ▲ or ▼ to select **All**, press OK_{MENU} to confirm.
3. OK_{MENU} After you enable this option, the call block icon will be displayed on the LCD.



12.8. Set Block Anonymous Calls OFF

In idle mode,

1. Repeat step 1 and 2 in Section 12.7.1.
2. Press **Ok**, press ▲ or ▼ to select **Off**, press **Ok** to confirm.
3.  will only disappear from the LCD if the regular call block (see 1. And 2.) is also set to OFF.

13. VOICE MAIL (Network Dependent)

By subscription to your operator, you can have your calls diverted to a voicemail box when you are absent. For more details, contact your operator.

When new messages are received,  appears on the screen. The  disappears once you have consulted the voicemail messages.

To reset the voicemail indicator:

1. Press **Ok** to select **Call list**.
2. Press ▲ or ▼ to select **Voice Mail**.
3. Long Press key 4, and then  should disappear.



14. ANSWERING MACHINE

The total storage capacity for the outgoing message, messages and memos is approximately 30 minutes.

Note: Your answering system will answer call after 14 rings even when the answering machine is turned off. This is to allow the remote access feature to work.

14.1. Turn On/Off the Answering Machine

If you turn the answering machine on, it answers calls and records messages.





The red message LED  on the telephone base is on and the  icon on the handset will be on too.

Through telephone base:

Press  key on the base to turn the answering machine on or off.



Note: When Answering machine is off, the red message LED  on the telephone base will be off and the  icon on the handset will be off too.

Through Cordless Handset:

1. Press  in idle mode.
2. Press ▲ or ▼ to select **Ans. Machine**, then press .
3. Press ▲ or ▼ to select **Tam On/Off**, then press .
4. Press ▲ or ▼ to select **On** or **Off**, then press  to save. You hear confirmation tones.



14.2. Message Playback

If 2 new voice messages are stored in the phone, "2 New Msgs" will appear



and the  icon will flash on the handset screen, the red message LED  on the telephone base will flash.

If memory is full, **Mem. Full** will display in the screen.

Listen new messages through the Cordless Handset:

1. Press  in idle mode.
2. Press ▲ or ▼ to select **Ans. Machine**, then press .
- To play new messages, press  to select **Playback**.
- Time and date of the message played will display on the screen if listened through handset.
- After end of all messages, "End of Messages" will appear.

14.3. Options during playback

- Press  to play the messages through the handset earpiece.
- Slide  up or down on side of handset to adjust the speakerphone volume.
- Press **6** to skip to the next message.
- Press **4** to repeat the message currently playing.
- Press **4** twice to listen to the previous message.
- Press **2** to delete the current message.
- Press **5** or  to stop.

OR,

During playback, press **Ok** to select options:

Stop

Forward

Previos

Delete

14.4. Listen new messages through the Base





1. Press ►/■ to listen to new messages through base speaker. After playback all new messages, a long beep will emit from the base.
2. To playback old messages, press ►/■ again to listen.

Options during playback:

- Slide left and right  on the side of base to adjust the speaker volume.
- Press ◀◀ to repeat the message currently playing.
- Press □ to delete the current message.
- Press ►/■ to stop.
- Press |||▶ to reduce the playback speed.

14.5. Delete Old Messages in the Answering Machine

14.5.1. Delete all old messages through the Handset

1. Press  in idle mode.
2. Press ▲ or ▼ to select **Ans. Machine**, then press .
3. **MSG Playback** appears and then press ▲ or ▼ to select **Delete All**, then press .
4. The handset displays **Confirm?**. Then press  to confirm.
5. The handset displays **Deleted...** and then **Deleted** is shown. You hear confirmation tones.

14.5.2. Delete a message through the Base

1. Press ►/■ to listen new or old messages through base speaker.
2. Press □ to delete the message being listened. You hear confirmation tones.

14.5.3. Delete all old messages through the Base

1. During idle mode, long press □ to delete all old messages. You hear confirmation tones.

14.5.4. Record a Memo

NOTE: All the procedures described below can also be performed from the telephone base. From there, the only difference is that the icon  described below corresponds to the telephone base key.

1. Press **Ok** in idle mode to enter the main menu.
2. Press ▲ or ▼ to select **Ans. Machine**, then press **Ok**.
3. **MSG Playback** appears and then press ▲ or ▼ to select **Memo**, then press **Ok**.
4. **Recording** shows on the screen. After the tone, speak towards the microphone.
5. Press **Ok** when you finish recording. **Playing ...** shows on the screen. Your recorded memo will be playback. then returns to the previous menu.
6. When another user listens the memo (procedure refers to Section 14.2 through handset or base), the time & date of the memo will display on the screen if listened through handset.



Notes:

- **Mem. Full** will display in the screen if you attempt to record a memo when the memory is full.
- Each memo can be up to 4 minutes in length.
- Memos shorter than two second are not recorded.

14.6. Outgoing Message (OGM)

The telephone is preset with a greeting that answers calls with "please leave a message after the tone." You can use this default outgoing message, or replace it with your own.

14.6.1. Play your Outgoing Message (OGM)

Through telephone base:

1. Press **Menu** in idle mode.
2. Press ▲ or ▼ to select **Ans. Machine**, then press **Ok**.
3. **Delete All** appears and then press ▲ or ▼ to select **OGM**, then press **Ok**.
4. **Ans & Rec** appears and then press **Ok**.
5. **Play OGM** appears then press **Ok**, **Playing** appears then it will play the default outgoing message.

Through cordless handset:

1. Press ^{OK}_{MENU} in idle mode.
2. Press ▲ or ▼ to select **Ans. Machine**, then press ^{OK}_{MENU}.
3. **MSG Playback** appears and then press ▲ or ▼ to select **Tam Settings**, then press ^{OK}_{MENU}.
4. **Ans & Rec** appears and then ^{OK}_{MENU}.
5. **Play OGM** appears then press **Ok**, **Playing...** appears then it will play the default outgoing message.

14.6.2. Record your own Outgoing Message (OGM)

Through telephone base:

1. Repeat step 1 to 4 in Section 14.6.1.
2. **Play OGM** appears and then press ▲ or ▼ to select **Rec. OGM**, and then press **Ok**.
3. **Recording...** appears and then you can record your outgoing message after beep tone.
4. After finishing record, press **Ok**.

Notes:

- Your outgoing message can be up to 90 seconds in length.
- Outgoing messages shorter than two seconds are not recorded.

Through cordless handset:

1. Repeat step 1 to 4 in Section 14.6.1.
2. **Play OGM** appears on the screen, then press ▼ to select **Record**, and then press **Ok**.
3. **Recording...** appears and then you can record your outgoing message after beep tone.
4. After finishing record, press **Ok**, **Playing...** appears then it will playback your own outgoing message.

14.7. Delete your Outgoing Message

Through telephone base:

1. Repeat step 1 to 2 in Section 14.6.1.
2. **Delete All** appears and then press ▲ or ▼ to select **OGM**, then press **Ok**.
3. **Ans & Rec** appears and then press **Ok**.
4. **Play OGM** appears, then ▲ or ▼ to select **Delete**, and then press **Ok**.
5. **Delete** will show, You hear confirmation tones.

Through cordless handset:

1. Repeat step 1 to 4 in Section 14.6.1.
2. **Play OGM** appears on the screen, then press ▼ to select **Delete**, and then press ^{OK}_{MENU}.
3. You hear confirmation tones.

14.8. Answering Machine Settings

14.8.1. Set the Answer Mode

By default, the answer machine is set in Ans & Rec mode which allows callers to leave a message. This mode can be changed to Answer Only which does not allow callers to leave a message. In that case, your callers will be prompted to call back later.

Through telephone base:

1. Press ≡ and ▲ or ▼ to select **Ans. Machine**.
2. Press **Ok** and ▲ or ▼ to select **TAM Settings**.
3. Press **Ok** and ▲ or ▼ to select **Answer Mode**.
4. Press **Ok** and ▲ or ▼ to select **Ans & Rec** or **Answer Only**.
5. Press **Ok** to confirm.

14.8.2. Set the Answer Delay

You can set the number of rings before the answering machine answers and starts playing your OGM. You can set the answering machine to answer after 2 to 10 rings or TOLL SAVE.

With TOLL SAVE selected, the answering machine answers after 2 rings when you have new messages, and after 4 rings when you have no new messages.

Through telephone base:

1. Press **Menu** in idle mode.
2. Press ▲ or ▼ to select **Ans. Machine**, then press **Ok**.
3. Press ▲ or ▼ to select **TAM Settings**, then press **Ok**.
4. Press ▲ or ▼ to select **Answer Delay**, then press **Ok**.
5. Press ▲ or ▼ to select **2, 4, 6, 8, 10 rings**, then press **Ok** to save. You hear confirmation tones.

Through cordless handset:

1. Press ^{OK}_{MENU} in idle mode.
2. Press ▲ or ▼ to select **Ans. Machine**, then press ^{OK}_{MENU}.
3. Press ▲ or ▼ to select **TAM Settings**, then press ^{OK}_{MENU}.
4. Press ▲ or ▼ to select **Answer Delay**, then press ^{OK}_{MENU}.
5. Press ▲ or ▼ to select **2, 4, 6, 8, 10 rings**, then press ^{OK}_{MENU} to save. You hear confirmation tones.

14.8.3. Recording Time

You can set the maximum length of the recording time of the incoming messages.

Through telephone base:

1. Repeat step 1 to 3 in Section 14.8.1.
2. Press ▲ or ▼ to select **Record Time**, then press **Ok**.
3. Press ▲ or ▼ to select **60s, 120s, 180s**, then press **Ok** to save. You hear confirmation tones.

Through cordless handset:

1. Repeat step 1 to 3 in Section 14.8.1.
2. Press ▲ or ▼ to select **Record Time**, then press ^{OK}_{MENU}.
3. Press ▲ or ▼ to select **60s, 120s, 180s**, then press ^{OK}_{MENU} to save. You hear confirmation tones.

14.8.4. Answering Machine Remote Access

You can access the answering machine remotely by dialling your fixed telephone number from any touch-tone telephone.

Your phone lets you check your messages, or otherwise operate your answering machine, by calling the answering machine when you are away from home by entering a 4-digit remote access PIN on a tone-dialing phone.

By default, the 4-digit remote access code is 0000. It is highly advised to modify it for privacy issues.

14.8.5. Activate Remote Access

Through telephone base:

1. Press **Menu** in idle mode.
2. Press ▲ or ▼ to select **Ans. Machine**, then press **Ok**.
3. Press ▲ or ▼ to select **TAM Settings**, then press **Ok**.
4. Press ▲ or ▼ to select **Remote Acc.**, then press **Ok**.
5. Press ▲ or ▼ to select **On** or **Off**, then press **Ok** to save. You hear confirmation tones.

Through cordless handset

1. Press ^{OK}_{MENU} in idle mode.
2. Press ▲ or ▼ to select **Ans. Machine**, then press ^{OK}_{MENU}.
3. Press ▲ or ▼ to select **TAM Settings**, then press ^{OK}_{MENU}.
4. Press ▲ or ▼ to select **Remote Acc.**, then press ^{OK}_{MENU}.
5. Press ▲ or ▼ to select **On** or **Off**, then press ^{OK}_{MENU} to save. You hear confirmation tones.

14.8.6. Change the remote code:

Through telephone base:

1. Repeat step 1 to 3 as above.
2. Press ▲ or ▼ to select **Change Pin**, then press **Ok** to enter a 4-digit number.
3. Press **OK** to save. You hear confirmation tones.

Through cordless handset:

1. Repeat step 1 to 3 as above.
2. Press ▲ or ▼ to select **Change Pin**, then press  to enter a 4-digit number

14.9. How to Access Remotely to your Answering Machine?

You can ring your phone from another tone-dialing phone to switch on or off the answering machine and listen to your messages remotely.

1. Place a call from a tone-dialing phone to your phone.
2. When the answering machine answers the calls and starts playing the outgoing message, enter * key and then 4-digit remote access code (0000 is the preset code).
3. Then the following description will operate by pressing the following key in your tone-dialing phone.



Keys	Description
2	Delete the message currently being played.
4	Repeat the current message or press twice for the previous message.
5	Play all messages.
6	Skip to the next message.
7	Turn on the answering machine.
9	Turn off the answering machine.

Note:

- After 5 seconds of key inactivity, the answering machine automatically cuts off communication.
- When the answering machine is turned off, the telephone answers after 14 rings, and plays the outgoing message.

14.10. Call Screening



When the answering machine is set to ON and when there is an incoming message, the base will start call screening if call screening is set to ON after the preset numbers of rings of answer delay, press **OK** to screen the call on your handset too.

At any time if you want to pick up the call, you can press  on the handset, or press  on the telephone base, or pick up combo handset and the message recording will be stopped automatically. If the answering machine is in the process of recording, the message already stored will be saved.



Through the telephone base:

1. Repeat step 1 to 3 in Section 14.6.1. (set answer delay)
2. **BS Screening** will display, then press **Ok**.
3. Press ▲ or ▼ to select between **On** and **Off**, then press **Ok** to save. You hear confirmation tones.



Through cordless handset:

1. Repeat step 1 to 3 in Section 14.6.1.
2. **BS Screening** will display, then press .
3. Press ▲ or ▼ to select between **On** and **Off**, then press  to save. You hear confirmation tones.

Options while a message is being recorded in the telephone base:

- Slide up/down  on the side of base to adjust the speaker volume.
- Press  to temporarily turn off the feature.

Options while a message is being recorded in the cordless handset:

- Press  to temporarily turn on the feature if it is set to off.
- Slide  up or down on side of handset to adjust the speakerphone volume.
- Press  to temporarily turn off the feature.

14.11. Message Alert Tone

When the message alert tone is set to On, the telephone base beeps every 10 seconds to alert you to new messages.

The tone stops when all new messages have been reviewed.

Through telephone base:

1. Press **Menu** in idle mode.
2. Press ▲ or ▼ to select **Ans. Machine**, then press **Ok**.
3. Press ▲ or ▼ to select **Tam Settings**, then press **Ok**.
4. Press ▲ or ▼ to select **Msg Alert**, then press **Ok**.
5. Press ▲ or ▼ to select **On** or **Off**, then press **Ok** to confirm. You hear confirmation tones.

Through cordless handset

1. Press ^{OK}_{MENU} in idle mode.
2. Press ▲ or ▼ to select **Ans. Machine**, then press ^{OK}_{MENU}.
3. Press ▲ or ▼ to select **Tam Settings**, then press ^{OK}_{MENU}.
4. Press ▲ or ▼ to select **Msg. Alert**, then press ^{OK}_{MENU}.
5. Press ▲ or ▼ to select **On** or **Off**, then press ^{OK}_{MENU} to confirm. You hear confirmation tones.

Pressing any telephone base key temporarily silences the message alert tone.

The message alert tone plays with the next incoming message.

15. TECHNICAL SPECIFICATIONS

Free Field Range	Up to 300 metres*
Indoor Range	Up to 50 metres*
Handset Battery Life (average values)	10 hours talk time** 100 hours standby**
Number of Handsets	Up to 4 (at maximum)
Intercom Mode	Yes
Three-Way Conference	Yes (1 external correspondent + 2 internal correspondents)
Electrical Connection/ Base Mains Adaptor/ Charger	Main base adapter and charger: Model No.: EU and DE version AT-337E-060045A or 1-CHEUA451-081 Model No.: UK version AT-536B-060045B or 1-CHUKA451-082 Input: 100-240 V/50-60 Hz/0.15A Output: 6V DC/450 mA, 2.7W Use only the adapters provided with the phone. Single-phase AC, excluding IT installations defined by the standard EN62368-1. Attention: The network voltage is classified as dangerous according to the criteria of this standard.
Telephone Connection	Appliance designed for connection to a TNV3 class (telecommunications network voltage) analogue telephone line as defined by the EN62368-1 standard.
Batteries	AAA NiMH batteries– 1.2 V (3 pieces) Only use the batteries supplied with the telephone. Use any other type of battery presents a risk of explosion. Used batteries must be disposed of in compliance with current environmental protection regulations.
Operating Temperature	From 5°C to 40°C

* Values may vary according to environment.

** Depending on initial battery charge.

16. TROUBLESHOOTING

If you have difficulty with your phone, please try the suggestions listed below.

As a general rule, if a problem occurs, remove the batteries from all the handsets in your installation for about 1 minute, then disconnect and reconnect the power supply to the base and reinstall the handset batteries.

Phone does not work

- Make sure you installed the batteries correctly.
- Check that the mains power is correctly connected for the charger.

“NO LINE” appears in the screen

- Is the telephone cord plugged into the phone socket?
- Only use the telephone cord supplied with the phone.
- The telephone line cord might be malfunctioning. Install a new telephone line cord.
- Disconnect the telephone and connect a different telephone. If there is no dial tone on this telephone, the problem is in your wiring or local service. Contact your local telephone company.

No dial tone

- Is the telephone cord plugged into the phone socket?
- Check that the mains power is switched on.
- Only use the telephone cord supplied with the phone.
- The telephone line cord might be malfunctioning. Install a new telephone line cord.
- Move the cordless handset closer to the telephone base. It might be out of range.
- Disconnect the telephone and connect a different telephone. If there is no dial tone on this telephone, the problem is in your wiring or local service. Contact your local telephone company.

Cannot dial out or receive calls

- Check that the mains power is correctly connected.
- The battery may need recharging.
- Has there been a power cut? If so, place the handset back on the base for 10 seconds and try again. If it still does not work disconnect the batteries and mains power for 10 minutes, then reconnect and try again.
- If you are connected to a PABX, check whether you need to dial an access code.

Your own voice cannot be announced when the telephone number of incoming call is same as 1 of 4 photo memories stored

- The ringer volume may be switched off.
- Voice recording in 1 of 4 photo memories was not done successfully. Please refer to Section 5.5.2. to record again.
- Your telephone line may not be subscribed or availability of the service from the fixed line operator.

Cordless handset does not ring (Caller Line Identification)

- The ringer volume may be switched off.
- Check that the mains power is correctly connected.
- Make sure the cordless handset is registered to the base.

No display in cordless handset

- The batteries may be flat, dead or incorrectly inserted.
- Recharge or replace the batteries

Handset displays “PUT ON BS TO POWER”

- Check that the mains power is correctly connected.
- Check that the cordless handset is within range of the base.

No voice tag announcement from cordless handset during ringing

- It should become normal after 1 minute in idle mode without any operation of the phone.

You hear the busy tone when you press  key on handset

- Make sure the cordless handset is in range of the base.
- Another cordless handset registered to your telephone base may be on the line.

No sounds or noise when using corded handset

- Make sure the coil cord connector between base and handset firmly plug.

No key tone on Base

- Check key tone setting is on.

Buzzing noise on my phone or on other electrical equipment nearby

- Sometimes your phone can interfere with other electrical equipment if it is placed too close. It is recommended that you place your phone at least one metre away from electrical appliances or metal obstructions to avoid any risk of interference.
- If you have an ADSL internet service ensure correct filters are installed to prevent interference.

Answering machine does not record any messages

- Make sure the answering machine is switched on.
- The memory may be full, please delete some old messages to free up space.

Cannot access your messages from another phone

- Have you changed the remote access security PIN code?
- Make sure you are calling from a touch-tone telephone. When dialling a number, there should be tones.
- The answering machine might not detect the remote access code when your outgoing message is playing. Try again to press remote access code quickly.
- There might be interference on the telephone line you are using. Press the dial pad keys firmly when dialing.

Vicemail and show on the display and I don't know why.

Your telephone has voicemail indication that is separate from the built-in answering system. If  appears on the display, then your telephone has received a signal from your telephone service provider that you have a voicemail message waiting for you to retrieve from your telephone service provider. Contact your telephone service provider for more information on how to access your voicemail.

The store where you bought your telephone can also provide you with information and after-sales support.

17. GUARANTEE

Please carefully read the user guide included in this box. Xtra 3355 is approved equipment in accordance with European regulations, attested by the CE mark. The product you just bought is a technological product, it must be handled with care.

Note: You have a legal warranty on this product in accordance with the regulations applicable to the sale of consumer goods in the country in which you made this purchase.

For any information regarding this legal warranty, please contact your dealer.

Without prejudice to the legal guarantee of the products, ATLINKS guarantees that the product in this box conforms to its technical specifications contained in the user guide included in the this box, and this during a warranty period, counted from the date of purchase of the new product, the date on your invoice or ticket checkout where is indicated the name of your reseller, and equal to: Twenty four (24) months for the telephone, excluding consumables, accessories and batteries. For any claim under this warranty during the warranty period, you must return the entire Product to your dealer, together with the proof of purchase, the invoice or receipt issued by your dealer, indicating the place of purchase and the serial number of the Product, following the appearance or discovery of the defect. ATLINKS undertakes to repair any defective item due to a defect in design, material or workmanship, at its expense, or to replace, at its expense, by an identical or at least equivalent element in terms of functionalities and performance.

If repair or replacement is impossible under normal commercial conditions, the Product will be refunded or replaced by a Product equivalent.

Within the maximum limit allowed by the applicable law, the product or element replacement, which may be new or reconditioned, is warranted during a period of ninety (90) days from the date of repair or until the end date of the initial warranty period,

whichever is the earlier greater than ninety (90) days, it being specified that any 48 period of immobilization of the Product of at least seven (7) days will be added to the warranty period remaining to run.

This warranty does not apply in the following cases:

- Installation or use not in accordance with the instructions in the guide of the user,
- Incorrect connection or abnormal use of the Product, especially with noncompatible accessories, as indicated in the user guide,
- Product opened, modified or replaced by means of non-approved parts, serial number deleted, illegible, damaged,
- Normal wear, including normal wear and tear on accessories, batteries and displays,
- Failure to comply with the technical and safety standards in force in the area geographical use,
- Product having suffered a shock or a fall,
- Product damaged by lightning, electrical surge, heat source or radiation, water damage, exposure to conditions of temperature, humidity or other excessive ambient conditions or any other cause external to the product,
- Negligence or faulty maintenance,
- A intervention, modification or repair carried out by a person not authorized by ATLINKS.

If the returned Product is not covered by the warranty, you will receive a quote from repair that will mention the cost of analysis and transportation costs that you will be charged if you want the Product returned to you.

This warranty is valid in the country in which you regularly purchased the Product, provided that this country is a member of the European Union. Subject to the legal provisions in force, these are expressly excluded.

TO THE MAXIMUM EXTENT PERMITTED BY APPLICABLE LAW,

A) THIS WARRANTY IS EXCLUSIVE OF ALL OTHER WARRANTIES, EXPRESS OR IMPLIED, INCLUDING BUT NOT LIMITED TO, WARRANTIES OF MERCHANTABILITY OR FITNESS FOR A PARTICULAR PURPOSE PARTICULAR

B) ATLINKS DISCLAIMS LIABILITY FOR LOSS OR DETERIORATION OF DATA, LOSS OF USE LOST TO WIN, LOSS OF CHANCE, DEREVENUES OR INCOME, LOSS OF OPERATION, DAMAGES INDIRECT, CONSEQUENTIAL, CONSEQUENTIAL OR INCIDENTAL

C) ATLINKS LIABILITY IS LIMITED TO THE VALUE OF PURCHASE OF PRODUCT EXCEPT HEAVILY OR UNINTENTIONAL FAULT AND EXCEPT DAMAGE BODY

18. SAFETY

In the event of an electrical hazard, the mains adapter acts as a 230 V electrical isolation device. It should therefore, as a precaution, be installed close to the appliance and be easily accessible. To disconnect the device from the primary power source, the mains adapter must be removed from the 230V AC/50 Hz socket.

If the mains adapter fails, it must be replaced by an identical model.

We recommend that you also keep a conventional telephone – one that doesn't require a power supply – as a backup.

! Do not use the phone to report a gas leak when standing in the vicinity of the leak.

It is recommended that you avoid using this device during electrical storms. Do not attempt to open the batteries, as they contain chemical substances. In the event of leakage, avoid contact with the skin, eyes, nose and mouth. In the event of contact, rinse the affected part for about twenty minutes with running water and seek urgent medical attention. Clean the product with absorbent paper or a dry cloth and contact your reseller for replacement batteries.

The logo printed on the products indicates the conformity with all essential requirements (RED directive: 2014/53/EU). You can download the Declaration of Conformity from our website - www.swissvoice.net
Then, select: Documentation/Downloads EU declaration of conformity



Hereby, ATLINKS EUROPE declares that the radio equipment is in compliance with Legislation: Radio Equipment Regulations 2017 (SI 2017/1206). The full text of the UKCA declaration of conformity is available at the following internet address: www.swissvoice.net



Average power per channel: 10mW
Maximum Output Power (NTP) : 24dBm
Frequency Range : 1880-1900MHz

19. ENVIRONMENT



This symbol means that your inoperative electronic device must be collected separately and must not be mixed with household waste. The European Union has set up a specific collection and recycling system for which manufacturers are responsible.

This appliance has been designed and manufactured with high quality materials and components that can be recycled and reused. Electrical and electronic appliances are liable to contain parts that are necessary in order for the system to work properly but which can become a health and environmental hazard if they are not handled or disposed of in the proper way. Consequently, please do not throw out your inoperative appliance with the household waste.

- If you are a professional user, please follow the instructions of your supplier.
- If you are the owner of the appliance, you must deposit it at the appropriate local collection point or leave it with the vendor when buying a new appliance.
- If the appliance is rented to you or left in your care, please contact your service provider.

Keen to preserve the environment, ATLINKS has equipped this appliance with a switching power supply, offering better energy efficiency. The advantages include not only very low electricity consumption, but also a more compact format than the conventional power supply units used by the previous range.

The used batteries from your telephone must be disposed of in compliance with current environmental protection regulations. Comply with your local regulations.

Return your batteries to your reseller or dispose of them at an approved recycling centre.

Help us protect the environment we live in!

ATLINKS Europe

28 Boulevard Belle Rive
92500 Rueil Malmaison – France
RCS Nanterre 508 823 747

ATLINKS UK Ltd

3rd Floor, Waverley House
7-12 Noel St.
London W1F 8GQ – UK
Company registration: 13809295

www.swissvoice.net

Swissvoice is a trademark of Swissvoice International SA.

©Copyright Swissvoice International SA 2023

The Manufacturer reserves the right to modify the specifications of its products
in order to make technical improvements or comply with new regulations.